

Varenummer: 03446220  
Beskrivelse: Fluro Heavy Duty Ledleje GE 220 GW-2RS  
Hul Ø220  
Note: 220

## Mål

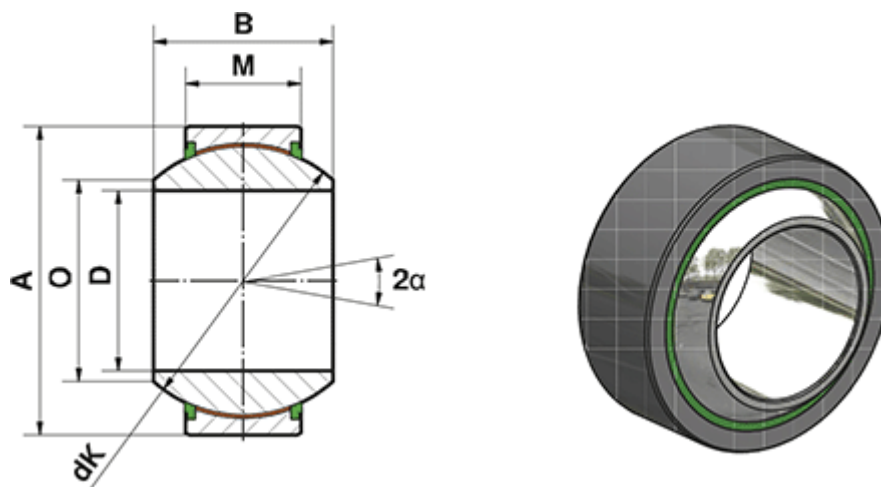

= -	Dynamisk belastning C (kN) = 7200
= -	M = 100
= -	O = 243.6
A = 340	Statisk belastning C0 (kN) = 12000
a (grader) = 16	Vægt (g) = 50800
B = 175	
D = 220	
dK = 300	